

M8 Male Moldable Cable Connector

Illustration

Scale drawing

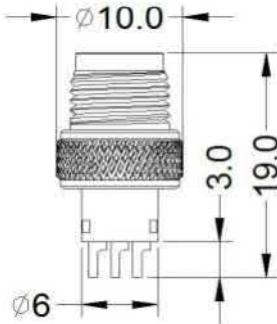

Generally Description:

Connector Series: M8
 Standard: IEC 61076-2-104
 Code: A, B
 Gender: Male
 Connector Design: Moldable Cable Connector
 Connector Locking System: Fix screw
 Waterproof Rating: IP67/IP68
 Normal Temperature: -10°C~+80°C

Material:

Connector Body: TPU
 Contacts: Brass with gold plated
 Screw/Nut: Brass with nickel plated

Electrical data:

Contact Resistance: $\leq 5m\Omega$
 Insulation Resistance: $\geq 100M\Omega$

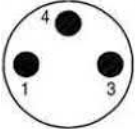
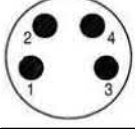
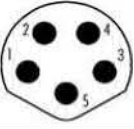
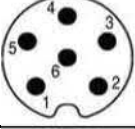
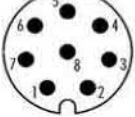
Contacts	A Code	B Code	Part Number	Rated Current	Rated Voltage		Normal Wire Gauge	
					AC	DC	AWG	mm ²
3pins			M8-MC3-041	3A	60V	60V	24AWG	0.25mm ²
4pins			M8-MC4-043	3A	30V	30V	24AWG	0.25mm ²
5pins			M8-MC5-045	3A	30V	30V	24AWG	0.25mm ²
6pins			M8-MC6-047	1A	30V	30V	26AWG	0.14mm ²
8pins			M8-MC8-049	1A	30V	30V	26AWG	0.14mm ²

Masterlink International Ltd.

Address: 2F., No.90, Sec.2, Xintai 5th Rd., Xizhi Dist., New Taipei City 221, Taiwan (R.O.C.)
 Web Site: www.master-link.com.tw E-mail: info@master-link.com.tw

M8 CONNECTOR / M8 CABLE ASSY'

M8 Female Moldable Cable Connector

Illustration

Scale drawing

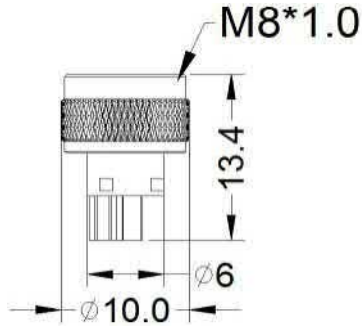

Generally Description:



Connector Series: M8
 Standard: IEC 61076-2-104
 Code: A, B
 Gender: Female
 Connector Design: Moldable cable connector
 Connector Locking System: Fix screw
 Waterproof Rating: IP67/IP68
 Normal Temperature: -10°C~+80°C

Material:

Connector Body: TPU
 Contacts: Phosphorus copper with gold plated
 Screw/Nut: Brass with nickel plated

Electrical data:

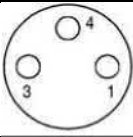
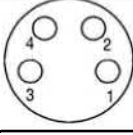
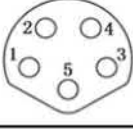
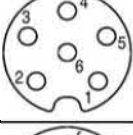
Contact Resistance: $\leq 5m\Omega$
 Insulation Resistance: $\geq 100M\Omega$

Contacts	A Code	B Code	Part Number	Rated Current	Rated Voltage		Normal Wire Gauge	
					AC	DC	AWG	mm ²
3pins			M8-FC3-042	3A	60V	60V	24AWG	0.25mm ²
4pins			M8-FC4-044	3A	30V	30V	24AWG	0.25mm ²
5pins			M8-FC5-046	3A	30V	30V	24AWG	0.25mm ²
6pins			M8-FC6-048	1A	30V	30V	26AWG	0.14mm ²
8pins			M8-FC8-050	1A	30V	30V	26AWG	0.14mm ²

Masterlink International Ltd.

Address: 2F., No.90, Sec.2, Xintai 5th Rd., Xizhi Dist., New Taipei City 221, Taiwan (R.O.C.)
 Web Site: www.master-link.com.tw E-mail: info@master-link.com.tw

M8 CONNECTOR / M8 CABLE ASSY'

M8 Male Straight Front Panel Mount Connector With Solder PCB Contacts

Illustration

Scale drawing

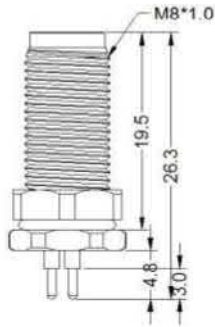

Generally Description:

Connector Series: M8
 Standard: IEC 61076-2-104
 Code: A, B
 Gender: Male
 Connector Design: Panel mount
 Connector Locking System: Fix screw
 Waterproof Rating: IP67/IP68
 Normal Temperature: -10°C~+80°C

Material:

Connector Body: TPU
 Contacts: Brass with gold plated
 Screw/Nut: Brass with nickel plated
 Waterproof O-ring: FKM
 Glue: Black epoxy resin

Electrical data:

Contact Resistance: $\leq 5m\Omega$
 Insulation Resistance: $\geq 100M\Omega$

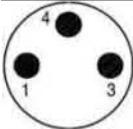
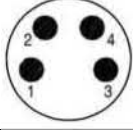
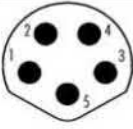
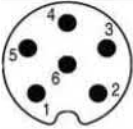
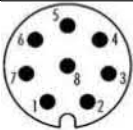
Contacts	A Code	B Code	Part Number	Rated Current	Rated Voltage	
					AC	DC
3pins			M8-MP3-001	3A	60V	60V
4pins			M8-MP4-005	3A	30V	30V
5pins			M8-MP5-009	3A	30V	30V
6pins			M8-MP6-013	1A	30V	30V
8pins			M8-MP8-017	1A	30V	30V

Masterlink International Ltd.

Address: 2F., No.90, Sec.2, Xintai 5th Rd., Xizhi Dist., New Taipei City 221, Taiwan (R.O.C.)
 Web Site: www.master-link.com.tw E-mail: info@master-link.com.tw

M8 CONNECTOR / M8 CABLE ASSY'

M8 Female Straight Front Panel Mount Connector With Solder PCB Contacts

Illustration

Scale drawing

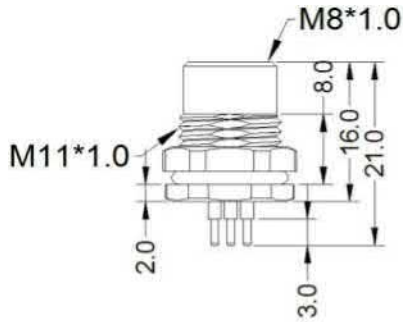

Generally Description:



Connector Series: M8
 Standard: IEC 61076-2-104
 Code: A, B
 Gender: Female
 Connector Design: Panel mount
 Connector Locking System: Fix screw
 Waterproof Rating: IP67/IP68
 Normal Temperature: -10°C~+80°C

Material:

Connector Body: TPU
 Contacts: Phosphorus copper with gold plated
 Screw/Nut: Brass with nickel plated
 Waterproof O-ring: FKM
 Glue: Black epoxy resin

Electrical data:

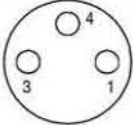
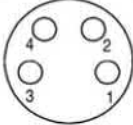
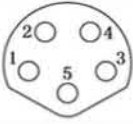
Contact Resistance: $\leq 5m\Omega$
 Insulation Resistance: $\geq 100M\Omega$

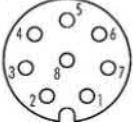
Contacts	A Code	B Code	Part Number	Rated Current	Rated Voltage	
					AC	DC
3pins			M8-FP3-003	3A	60V	60V
4pins			M8-FP4-007	3A	30V	30V
5pins			M8-FP5-011	3A	30V	30V
6pins			M8-FP6-015	1A	30V	30V
8pins			M8-FP8-019	1A	30V	30V

Masterlink International Ltd.

Address: 2F., No.90, Sec.2, Xintai 5th Rd., Xizhi Dist., New Taipei City 221, Taiwan (R.O.C.)
 Web Site: www.master-link.com.tw E-mail: info@master-link.com.tw

M8 CONNECTOR / M8 CABLE ASSY'

M8 Male Straight Rear Panel Mount Connector With Solder PCB Contacts

Illustration

Scale drawing

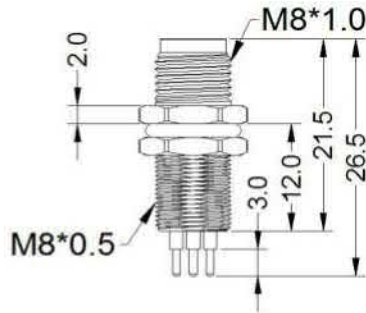

Generally Description:

Connector Series: M8
 Standard: IEC 61076-2-104
 Code: A, B
 Gender: Male
 Connector Design: Panel mount
 Connector Locking System: Fix screw
 Waterproof Rating: IP67/IP68
 Normal Temperature: -10°C~+80°C

Material:

Connector Body: TPU
 Contacts: Brass with gold plated
 Screw/Nut: Brass with nickel plated
 Waterproof O-ring: FKM
 Glue: Black epoxy resin

Electrical data:

Contact Resistance: $\leq 5\text{m}\Omega$
 Insulation Resistance: $\geq 100\text{M}\Omega$

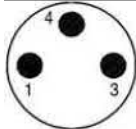
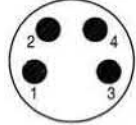
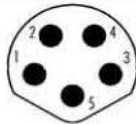
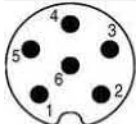
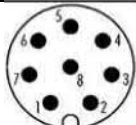
Contacts	A Code	B Code	Part Number	Rated Current	Rated Voltage	
					AC	DC
3pins			M8-MP3-002	3A	60V	60V
4pins			M8-MP4-006	3A	30V	30V
5pins			M8-MP5-010	3A	30V	30V
6pins			M8-MP6-014	1A	30V	30V
8pins			M8-MP8-018	1A	30V	30V

Masterlink International Ltd.

Address: 2F., No.90, Sec.2, Xintai 5th Rd., Xizhi Dist., New Taipei City 221, Taiwan (R.O.C.)
 Web Site: www.master-link.com.tw E-mail: info@master-link.com.tw

M8 CONNECTOR / M8 CABLE ASSY'

M8 Female Straight Rear Panel Mount Connector With Solder PCB Contacts

Illustration

Scale drawing

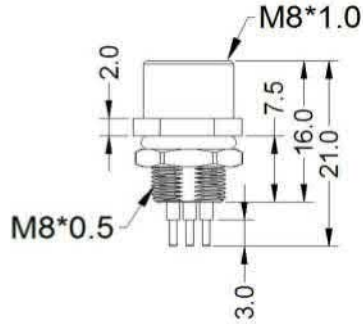

Generally Description:

Connector Series: M8
 Standard: IEC 61076-2-104
 Code: A, B
 Gender: Female
 Connector Design: Panel mount
 Connector Locking System: Fix screw
 Waterproof Rating: IP67/IP68
 Normal Temperature: -10°C~+80°C

Material:

Connector Body: TPU
 Contacts: Phosphorus copper with gold plated
 Screw/Nut: Brass with nickel plated
 Waterproof O-ring: FKM
 Glue: Black epoxy resin

Electrical data:

Contact Resistance: $\leq 5m\Omega$
 Insulation Resistance: $\geq 100M\Omega$

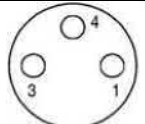
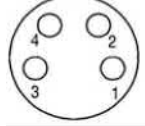
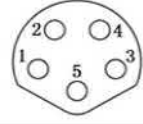
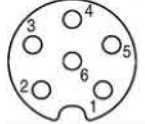
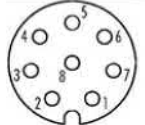
Contacts	A Code	B Code	Part Number	Rated Current	Rated Voltage	
					AC	DC
3pins			M8-FP3-004	3A	60V	60V
4pins			M8-FP4-008	3A	30V	30V
5pins			M8-FP5-012	3A	30V	30V
6pins			M8-FP6-016	1A	30V	30V
8pins			M8-FP8-020	1A	30V	30V

Masterlink International Ltd.

Address: 2F., No.90, Sec.2, Xintai 5th Rd., Xizhi Dist., New Taipei City 221, Taiwan (R.O.C.)
 Web Site: www.master-link.com.tw E-mail: info@master-link.com.tw

M8 CONNECTOR / M8 CABLE ASSY'

M8 Male Straight Front Panel Mount Connector With Wires

Illustration

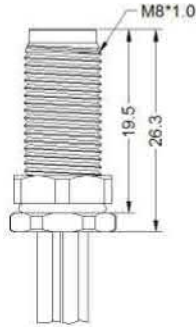

Scale drawing



Generally Description:

Connector Series: M8
 Standard: IEC 61076-2-104
 Code: A, B
 Gender: Male
 Connector Design: Panel mount
 Connector Locking System: Fix screw
 Waterproof Rating: IP67/IP68
 Normal Temperature: -10°C~+80°C

Material:

Connector Body: TPU
 Contacts: Brass with gold plated
 Screw/Nut: Brass with nickel plated
 Waterproof O-ring: FKM
 Glue: Black epoxy resin

Electrical data:

Contact Resistance: $\leq 5\text{m}\Omega$
 Insulation Resistance: $\geq 100\text{M}\Omega$

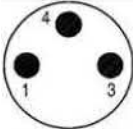
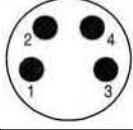
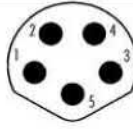
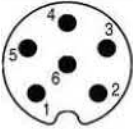
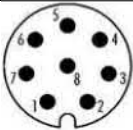
Contacts	A Code	B Code	Part Number	Rated Current	Rated Voltage		Normal Wire Gauge	
					AC	DC	AWG	mm ²
3pins			M8-MP3-001-W	3A	60V	60V	24AWG	0.24mm ²
4pins			M8-MP4-005-W	3A	30V	30V	24AWG	0.24mm ²
5pins			M8-MP5-009-W	3A	30V	30V	24AWG	0.24mm ²
6pins			M8-MP6-013-W	1A	30V	30V	26AWG	0.14mm ²
8pins			M8-MP8-017-W	1A	30V	30V	26AWG	0.14mm ²

Masterlink International Ltd.

Address: 2F., No.90, Sec.2, Xintai 5th Rd., Xizhi Dist., New Taipei City 221, Taiwan (R.O.C.)
 Web Site: www.master-link.com.tw E-mail: info@master-link.com.tw

M8 CONNECTOR / M8 CABLE ASSY'

M8 Female Straight Front Panel Mount Connector With Wires

Illustration

Scale drawing

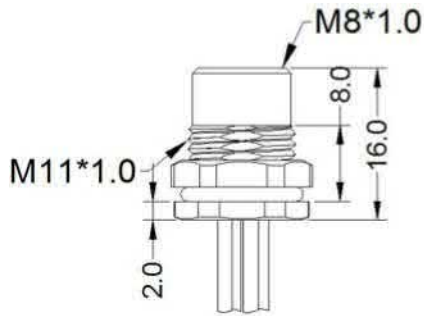

Generally Description:

Connector Series: M8
 Standard: IEC 61076-2-104
 Code: A, B
 Gender: Female
 Connector Design: Panel mount
 Connector Locking System: Fix screw
 Waterproof Rating: IP67/IP68
 Normal Temperature: -10°C~+80°C

Material:

Connector Body: TPU
 Contacts: Phosphorus copper with gold plated
 Screw/Nut: Brass with nickel plated
 Waterproof O-ring: FKM
 Glue: Black epoxy resin

Electrical data:

Contact Resistance: $\leq 5m\Omega$
 Insulation Resistance: $\geq 100M\Omega$

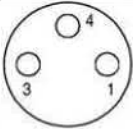
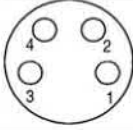
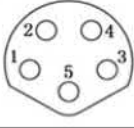
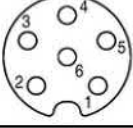
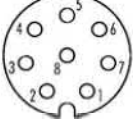
Contacts	A Code	B Code	Part Number	Rated Current	Rated Voltage		Normal Wire Gauge	
					AC	DC	AWG	mm ²
3pins			M8-FP3-003-W	3A	60V	60V	24AWG	0.24mm ²
4pins			M8-FP4-007-W	3A	30V	30V	24AWG	0.24mm ²
5pins			M8-FP5-011-W	3A	30V	30V	24AWG	0.24mm ²
6pins			M8-FP6-015-W	1A	30V	30V	26AWG	0.14mm ²
8pins			M8-FP8-019-W	1A	30V	30V	26AWG	0.14mm ²

Masterlink International Ltd.

Address: 2F., No.90, Sec.2, Xintai 5th Rd., Xizhi Dist., New Taipei City 221, Taiwan (R.O.C.)
 Web Site: www.master-link.com.tw E-mail: info@master-link.com.tw

M8 CONNECTOR / M8 CABLE ASSY'

M8 Male Straight Rear Panel Mount Connector With Wires

Illustration

Scale drawing

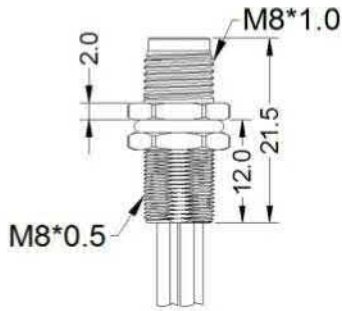

Generally Description:

Connector Series: M8
 Standard: IEC 61076-2-104
 Code: A, B
 Gender: Male
 Connector Design: Panel mount
 Connector Locking System: Fix screw
 Waterproof Rating: IP67/IP68
 Normal Temperature: -10°C~+80°C

Material:

Connector Body: TPU
 Contacts: Brass with gold plated
 Screw/Nut: Brass with nickel plated
 Waterproof O-ring: FKM
 Glue: Black epoxy resin

Electrical data:

Contact Resistance: $\leq 5\text{m}\Omega$
 Insulation Resistance: $\geq 100\text{M}\Omega$

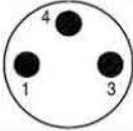
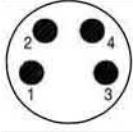
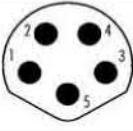
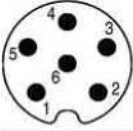
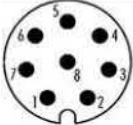
Contacts	A Code	B Code	Part Number	Rated Current	Rated Voltage		Normal Wire Gauge	
					AC	DC	AWG	mm ²
3pins			M8-MP3-002-W	3A	60V	60V	24AWG	0.24mm ²
4pins			M8-MP4-006-W	3A	30V	30V	24AWG	0.24mm ²
5pins			M8-MP5-010-W	3A	30V	30V	24AWG	0.24mm ²
6pins			M8-MP6-014-W	1A	30V	30V	26AWG	0.14mm ²
8pins			M8-MP8-018-W	1A	30V	30V	26AWG	0.14mm ²

Masterlink International Ltd.

Address: 2F., No.90, Sec.2, Xintai 5th Rd., Xizhi Dist., New Taipei City 221, Taiwan (R.O.C.)
 Web Site: www.master-link.com.tw E-mail: info@master-link.com.tw

M8 CONNECTOR / M8 CABLE ASSY'

M8 Female Straight Rear Panel Mount Connector With Wires

Illustration

Scale drawing

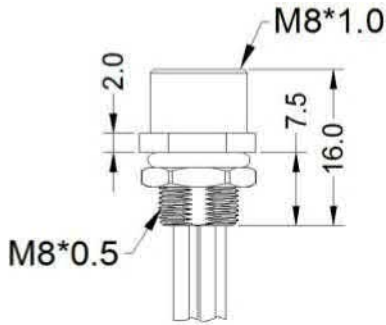

Generally Description:



Connector Series: M8
 Standard: IEC 61076-2-104
 Code: A, B
 Gender: Female
 Connector Design: Panel mount
 Connector Locking System: Fix screw
 Waterproof Rating: IP67/IP68
 Normal Temperature: -10°C~+80°C

Material:

Connector Body: TPU
 Contacts: Phosphorus copper with gold plated
 Screw/Nut: Brass with nickel plated
 Waterproof O-ring: FKM
 Glue: Black epoxy resin

Electrical data:

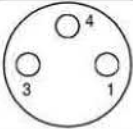
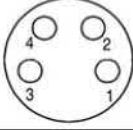
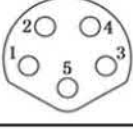
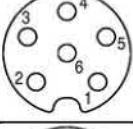
Contact Resistance: $\leq 5\text{m}\Omega$
 Insulation Resistance: $\geq 100\text{M}\Omega$

Contacts	A Code	B Code	Part Number	Rated Current	Rated Voltage		Normal Wire Gauge	
					AC	DC	AWG	mm ²
3pins			M8-FP3-004-W	3A	60V	60V	24AWG	0.24mm ²
4pins			M8-FP4-008-W	3A	30V	30V	24AWG	0.24mm ²
5pins			M8-FP5-012-W	3A	30V	30V	24AWG	0.24mm ²
6pins			M8-FP6-016-W	1A	30V	30V	26AWG	0.14mm ²
8pins			M8-FP8-020-W	1A	30V	30V	26AWG	0.14mm ²

Masterlink International Ltd.

Address: 2F., No.90, Sec.2, Xintai 5th Rd., Xizhi Dist., New Taipei City 221, Taiwan (R.O.C.)
 Web Site: www.master-link.com.tw E-mail: info@master-link.com.tw

M8 CONNECTOR / M8 CABLE ASSY'

M8 A Code Male Straight Plastic Assembly Connector

Illustration

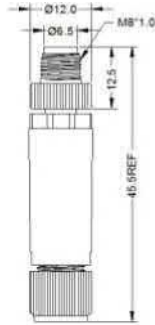

Scale drawing



Generally Description:

Connector Series: M8
 Standard: IEC 61076-2-104
 Code: A
 Gender: Male
 Connector Design: Cable assembly connector
 Connector Locking System: Fix screw
 Waterproof Rating: IP67/IP68
 Normal Temperature: -10°C~+80°C
 Cable Diameter: 3.5mm~5mm

Material:

Connector Body: PA66+GF
 Contacts: Brass with gold plated
 Screw/Nut: Brass with nickel plated
 Waterproof O-ring: FKM

Electrical data:

Contact Resistance: $\leq 5m\Omega$
 Insulation Resistance: $\geq 100M\Omega$

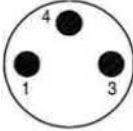
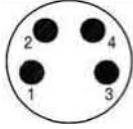
Contacts	A Code	Part Number	Rated Current	Rated Voltage		Normal Wire Gauge	
				AC	DC	AWG	mm ²
3pins		M8-MC3-001-S	3A	60V	60V	24AWG	0.25mm ²
4pins		M8-MC4-003-S	3A	30V	30V	24AWG	0.25mm ²

Masterlink International Ltd.

Address: 2F., No.90, Sec.2, Xintai 5th Rd., Xizhi Dist., New Taipei City 221, Taiwan (R.O.C.)
 Web Site: www.master-link.com.tw E-mail: info@master-link.com.tw

M8 CONNECTOR / M8 CABLE ASSY'

M8 A Code Female Straight Plastic Assembly Connector

Illustration



Scale drawing



Generally Description:

Connector Series: M8
 Standard: IEC 61076-2-104
 Code: A
 Gender: Female
 Connector Design: Cable assembly connector
 Connector Locking System: Fix screw
 Waterproof Rating: IP67/IP68
 Normal Temperature: -10°C~+80°C
 Cable Diameter: 3.5mm~5mm

Material:

Connector Body: PA66+GF
 Contacts: Phosphorus copper with gold plated
 Screw/Nut: Brass with nickel plated
 Waterproof O-ring: FKM

Electrical data:

Contact Resistance: $\leq 5m\Omega$
 Insulation Resistance: $\geq 100M\Omega$

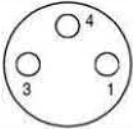
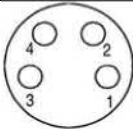
Contacts	A Code	Part Number	Rated Current	Rated Voltage		Normal Wire Gauge	
				AC	DC	AWG	mm ²
3pins		M8-FC3-002-S	3A	60V	60V	24AWG	0.25mm ²
4pins		M8-FC4-004-S	3A	30V	30V	24AWG	0.25mm ²

Masterlink International Ltd.

M8 CONNECTOR / M8 CABLE ASSY'

Illustration

Scale drawing

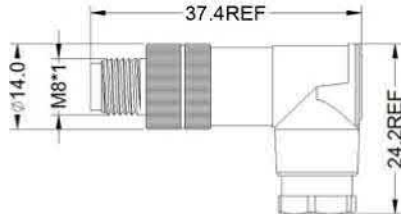

Generally Description:

Connector Series: M8
 Standard: IEC 61076-2-104
 Code: A
 Gender: Male
 Connector Design: Cable assembly connector
 Connector Locking System: Fix screw
 Waterproof Rating: IP67/IP68
 Normal Temperature: -10°C~+80°C
 Cable Diameter: 3.5mm~5mm

Material:

Connector Body: PA66+GF
 Contacts: Brass with gold plated
 Screw/Nut: Brass with nickel plated
 Waterproof O-ring: FKM

Electrical data:

Contact Resistance: $\leq 5m\Omega$
 Insulation Resistance: $\geq 100M\Omega$

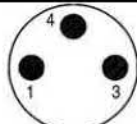
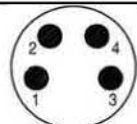
Contacts	A Code	Part Number	Rated Current	Rated Voltage		Normal Wire Gauge	
				AC	DC	AWG	mm ²
3pins		M8-MC3-005-S	3A	60V	60V	24AWG	0.25mm ²
4pins		M8-MC4-007-S	3A	30V	30V	24AWG	0.25mm ²

Masterlink International Ltd.

M8 CONNECTOR / M8 CABLE ASSY'

Illustration

Scale drawing

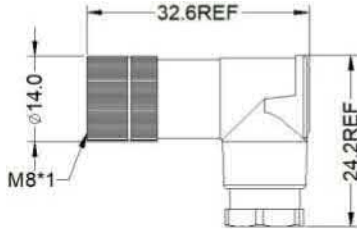

Generally Description:

Connector Series: M8
 Standard: IEC 61076-2-104
 Code: A
 Gender: Female
 Connector Design: Cable assembly connector
 Connector Locking System: Fix screw
 Waterproof Rating: IP67/IP68
 Normal Temperature: -10°C~+80°C
 Cable Diameter: 3.5mm~5mm

Material:

Connector Body: PA66+GF
 Contacts: Phosphorus copper with gold plated
 Screw/Nut: Brass with nickel plated
 Waterproof O-ring: FKM

Electrical data:

Contact Resistance: $\leq 5m\Omega$
 Insulation Resistance: $\geq 100M\Omega$

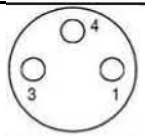
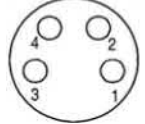
Contacts	A Code	Part Number	Rated Current	Rated Voltage		Normal Wire Gauge	
				AC	DC	AWG	mm ²
3pins		M8-FC3-006-S	3A	60V	60V	24AWG	0.25mm ²
4pins		M8-FC4-008-S	3A	30V	30V	24AWG	0.25mm ²

Masterlink International Ltd.

Address: 2F., No.90, Sec.2, Xintai 5th Rd., Xizhi Dist., New Taipei City 221, Taiwan (R.O.C.)
 Web Site: www.master-link.com.tw E-mail: info@master-link.com.tw

M8 CONNECTOR / M8 CABLE ASSY'

M8 Male Straight Molded Cable, PVC

Illustration

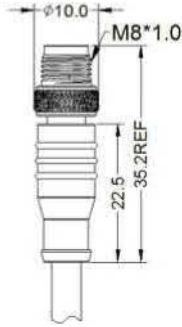

Scale drawing



Generally Description:

Connector Series: M8
 Standard: IEC 61076-2-104
 Code: A, B
 Gender: Male
 Connector Design: Moldable Cable Connector
 Connector Locking System: Fix screw
 Waterproof Rating: IP67/IP68
 Normal Temperature: -10°C~+80°C

Material:

Connector Body: TPU
 Contacts: Brass with gold plated
 Screw/Nut: Brass with nickel plated
 Over-mold: TPU
 Cable Jacket: PVC

Electrical data:

Contact Resistance: $\leq 5m\Omega$
 Insulation Resistance: $\geq 100M\Omega$

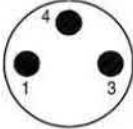
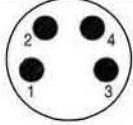
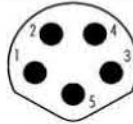
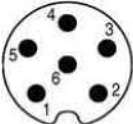
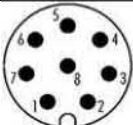
Contacts	A Code	B Code	Part Number		Rated Current	Rated Voltage		Normal Wire Gauge
			-10°C~+80°C	-40°C~+105°C		AC	DC	
3pins			M8-CM3-001	8L041	3A	60V	60V	24AWG 0.25mm ²
4pins			M8-CM4-005	8L045	3A	30V	30V	24AWG 0.25mm ²
5pins			M8-CM5-009	8L049	3A	30V	30V	24AWG 0.25mm ²
6pins			M8-CM6-013	8L053	1A	30V	30V	26AWG 0.14mm ²
8pins			M8-CM8-017	8L057	1A	30V	30V	26AWG 0.14mm ²

Masterlink International Ltd.

Address: 2F., No.90, Sec.2, Xintai 5th Rd., Xizhi Dist., New Taipei City 221, Taiwan (R.O.C.)
 Web Site: www.master-link.com.tw E-mail: info@master-link.com.tw

M8 CONNECTOR / M8 CABLE ASSY'

M8 Male Straight Molded Cable, PUR

Illustration

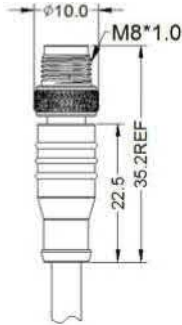

Scale drawing



Generally Description:

Connector Series: M8
 Standard: IEC 61076-2-104
 Code: A, B
 Gender: Male
 Connector Design: Moldable Cable Connector
 Connector Locking System: Fix screw
 Waterproof Rating: IP67/IP68
 Normal Temperature: -10°C~+80°C

Material:

Connector Body: TPU
 Contacts: Brass with gold plated
 Screw/Nut: Brass with nickel plated
 Over-mold: TPU
 Cable Jacket: PUR

Electrical data:

Contact Resistance: $\leq 5m\Omega$
 Insulation Resistance: $\geq 100M\Omega$

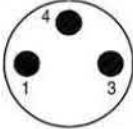
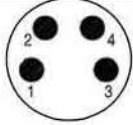
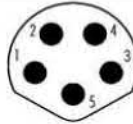
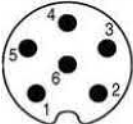
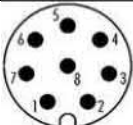
Contacts	A Code	B Code	Part Number		Rated Current	Rated Voltage		Normal Wire Gauge
			-10°C~+80°C	-40°C~+105°C		AC	DC	
3pins			M8-CM3-082	8L123	3A	60V	60V	24AWG 0.25mm ²
4pins			M8-CM4-086	8L127	3A	30V	30V	24AWG 0.25mm ²
5pins			M8-CM5-131	8L090	3A	30V	30V	24AWG 0.25mm ²
6pins			M8-CM6-094	8L135	1A	30V	30V	26AWG 0.14mm ²
8pins			M8-CM8-098	8L139	1A	30V	30V	26AWG 0.14mm ²

Masterlink International Ltd.

Address: 2F., No.90, Sec.2, Xintai 5th Rd., Xizhi Dist., New Taipei City 221, Taiwan (R.O.C.)
 Web Site: www.master-link.com.tw E-mail: info@master-link.com.tw

M8 CONNECTOR / M8 CABLE ASSY'

M8 Male Straight Molded Cable With Shielded, PVC

Illustration

Scale drawing

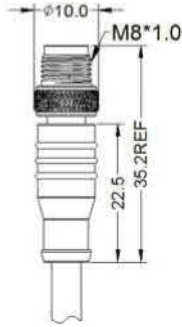

Generally Description:

Connector Series: M8
 Standard: IEC 61076-2-104
 Code: A, B
 Gender: Male
 Connector Design: Moldable Cable Connector
 Connector Locking System: Fix screw
 Waterproof Rating: IP67/IP68
 Normal Temperature: -10°C~+80°C

Material:

Connector Body: TPU
 Contacts: Brass with gold plated
 Screw/Nut: Brass with nickel plated
 Over-mold: TPU
 Cable Jacket: PVC

Electrical data:

Contact Resistance: $\leq 5m\Omega$
 Insulation Resistance: $\geq 100M\Omega$

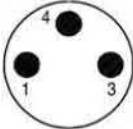
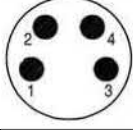
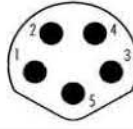
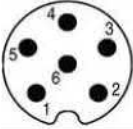
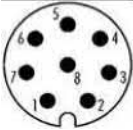
Contacts	A Code	B Code	Part Number		Rated Current	Rated Voltage		Normal Wire Gauge
			-10°C~+80°C	-40°C~+105°C		AC	DC	
3pins			M8-CM3-021	M8-CM3-061	3A	60V	60V	24AWG 0.25mm ²
4pins			M8-CM4-025	M8-CM4-065	3A	30V	30V	24AWG 0.25mm ²
5pins			M8-CM5-029	M8-CM5-069	3A	30V	30V	24AWG 0.25mm ²
6pins			M8-CM6-033	M8-CM6-073	1A	30V	30V	26AWG 0.14mm ²
8pins			M8-CM8-037	M8-CM8-077	1A	30V	30V	26AWG 0.14mm ²

Masterlink International Ltd.

Address: 2F., No.90, Sec.2, Xintai 5th Rd., Xizhi Dist., New Taipei City 221, Taiwan (R.O.C.)
 Web Site: www.master-link.com.tw E-mail: info@master-link.com.tw

M8 CONNECTOR / M8 CABLE ASSY'

M8 Male Straight Molded Cable With Shielded, PUR

Illustration

Scale drawing

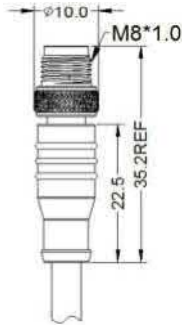

Generally Description:

Connector Series: M8
 Standard: IEC 61076-2-104
 Code: A, B
 Gender: Male
 Connector Design: Moldable Cable Connector
 Connector Locking System: Fix screw
 Waterproof Rating: IP67/IP68
 Normal Temperature: -10°C~+80°C

Material:

Connector Body: TPU
 Contacts: Brass with gold plated
 Screw/Nut: Brass with nickel plated
 Over-mold: TPU
 Cable Jacket: PUR

Electrical data:

Contact Resistance: $\leq 5m\Omega$
 Insulation Resistance: $\geq 100M\Omega$

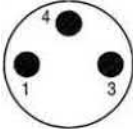
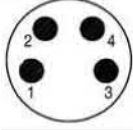
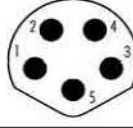
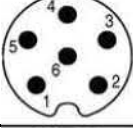
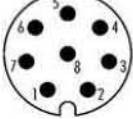
Contacts	A Code	B Code	Part Number		Rated Current	Rated Voltage		Normal Wire Gauge
			-10°C~+80°C	-40°C~+105°C		AC	DC	
3pins			M8-CM3-143	M8-CM3-102	3A	60V	60V	24AWG 0.25mm ²
4pins			M8-CM4-147	M8-CM4-106	3A	30V	30V	24AWG 0.25mm ²
5pins			M8-CM5-151	M8-CM5-110	3A	30V	30V	24AWG 0.25mm ²
6pins			M8-CM6-155	M8-CM6-114	1A	30V	30V	26AWG 0.14mm ²
8pins			M8-CM8-159	M8-CM8-118	1A	30V	30V	26AWG 0.14mm ²

Masterlink International Ltd.

Address: 2F., No.90, Sec.2, Xintai 5th Rd., Xizhi Dist., New Taipei City 221, Taiwan (R.O.C.)
 Web Site: www.master-link.com.tw E-mail: info@master-link.com.tw

M8 CONNECTOR / M8 CABLE ASSY'

M8 Female Straight Molded Cable, PVC

Illustration

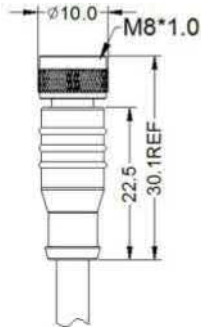

Scale drawing



Generally Description:

Connector Series: M8
 Standard: IEC 61076-2-104
 Code: A, B
 Gender: Female
 Connector Design: Moldable Cable Connector
 Connector Locking System: Fix screw
 Waterproof Rating: IP67/IP68
 Normal Temperature: -10°C~+80°C

Material:

Connector Body: TPU
 Contacts: Phosphorus copper with gold plated
 Screw/Nut: Brass with nickel plated
 Over-mold: TPU
 Cable Jacket: PVC

Electrical data:

Contact Resistance: $\leq 5m\Omega$
 Insulation Resistance: $\geq 100M\Omega$

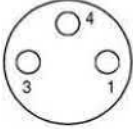
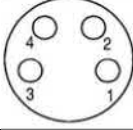
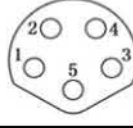
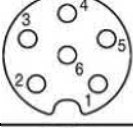
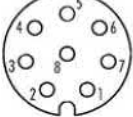
Contacts	A Code	B Code	Part Number		Rated Current	Rated Voltage		Normal Wire Gauge
			-10°C~+80°C	-40°C~+105°C		AC	DC	
3pins			M8-CF3-002	M8-CF3-042	3A	60V	60V	24AWG 0.25mm ²
4pins			M8-CF4-006	M8-CF4-046	3A	30V	30V	24AWG 0.25mm ²
5pins			M8-CF5-010	M8-CF5-050	3A	30V	30V	24AWG 0.25mm ²
6pins			M8-CF6-014	M8-CF6-054	1A	30V	30V	26AWG 0.14mm ²
8pins			M8-CF8-018	M8-CF8-058	1A	30V	30V	26AWG 0.14mm ²

Masterlink International Ltd.

M8 CONNECTOR / M8 CABLE ASSY'

M8 Female Straight Molded Cable, PUR

Illustration

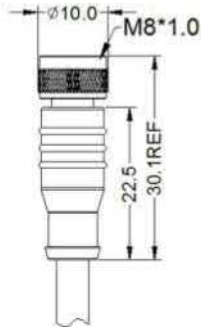

Scale drawing



Generally Description:



Connector Series: M8
 Standard: IEC 61076-2-104
 Code: A, B
 Gender: Female
 Connector Design: Moldable Cable Connector
 Connector Locking System: Fix screw
 Waterproof Rating: IP67/IP68
 Normal Temperature: -10°C~+80°C

Material:

Connector Body: TPU
 Contacts: Phosphorus copper with gold plated
 Screw/Nut: Brass with nickel plated
 Over-mold: TPU
 Cable Jacket: PUR

Electrical data:

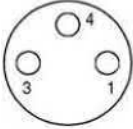
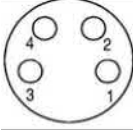
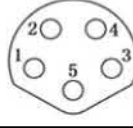
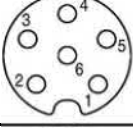
Contact Resistance: $\leq 5m\Omega$
 Insulation Resistance: $\geq 100M\Omega$

Contacts	A Code	B Code	Part Number		Rated Current	Rated Voltage		Normal Wire Gauge
			-10°C~+80°C	-40°C~+105°C		AC	DC	
3pins			M8-CF3-124	M8-CF3-083	3A	60V	60V	24AWG 0.25mm ²
4pins			M8-CF4-128	M8-CF4-087	3A	30V	30V	24AWG 0.25mm ²
5pins			M8-CF5-132	M8-CF5-091	3A	30V	30V	24AWG 0.25mm ²
6pins			M8-CF6-136	M8-CF6-095	1A	30V	30V	26AWG 0.14mm ²
8pins			M8-CF8-140	M8-CF8-099	1A	30V	30V	26AWG 0.14mm ²

Masterlink International Ltd.

Address: 2F., No.90, Sec.2, Xintai 5th Rd., Xizhi Dist., New Taipei City 221, Taiwan (R.O.C.)
 Web Site: www.master-link.com.tw E-mail: info@master-link.com.tw

M8 CONNECTOR / M8 CABLE ASSY'

M8 Female Straight Molded Cable With Shielded, PVC

Illustration

Scale drawing

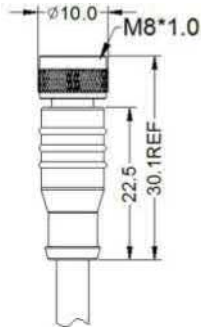

Generally Description:



Connector Series: M8
 Standard: IEC 61076-2-104
 Code: A, B
 Gender: Female
 Connector Design: Moldable Cable Connector
 Connector Locking System: Fix screw
 Waterproof Rating: IP67/IP68
 Normal Temperature: -10°C~+80°C

Material:

Connector Body: TPU
 Contacts: Phosphorus copper with gold plated
 Screw/Nut: Brass with nickel plated
 Over-mold: TPU
 Cable Jacket: PVC

Electrical data:

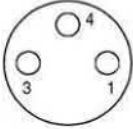
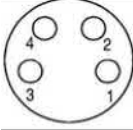
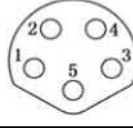
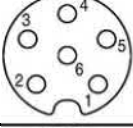
Contact Resistance: $\leq 5m\Omega$
 Insulation Resistance: $\geq 100M\Omega$

Contacts	A Code	B Code	Part Number		Rated Current	Rated Voltage		Normal Wire Gauge
			-10°C~+80°C	-40°C~+105°C		AC	DC	
3pins			M8-CF3-022	M8-CF3-062	3A	60V	60V	24AWG 0.25mm ²
4pins			M8-CF4-026	M8-CF4-066	3A	30V	30V	24AWG 0.25mm ²
5pins			M8-CF5-030	M8-CF5-070	3A	30V	30V	24AWG 0.25mm ²
6pins			M8-CF6-034	M8-CF6-074	1A	30V	30V	26AWG 0.14mm ²
8pins			M8-CF8-038	M8-CF8-078	1A	30V	30V	26AWG 0.14mm ²

Masterlink International Ltd.

Address: 2F., No.90, Sec.2, Xintai 5th Rd., Xizhi Dist., New Taipei City 221, Taiwan (R.O.C.)
 Web Site: www.master-link.com.tw E-mail: info@master-link.com.tw

M8 CONNECTOR / M8 CABLE ASSY'

M8 Female Straight Molded Cable With Shielded, PUR

Illustration

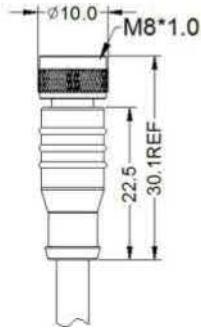

Scale drawing



Generally Description:



Connector Series: M8
 Standard: IEC 61076-2-104
 Code: A, B
 Gender: Female
 Connector Design: Moldable Cable Connector
 Connector Locking System: Fix screw
 Waterproof Rating: IP67/IP68
 Normal Temperature: -10°C~+80°C

Material:

Connector Body: TPU
 Contacts: Phosphorus copper with gold plated
 Screw/Nut: Brass with nickel plated
 Over-mold: TPU
 Cable Jacket: PUR

Electrical data:

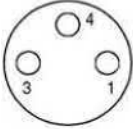
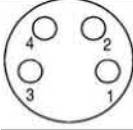
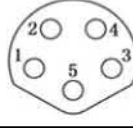
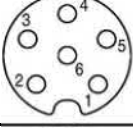
Contact Resistance: $\leq 5m\Omega$
 Insulation Resistance: $\geq 100M\Omega$

Contacts	A Code	B Code	Part Number		Rated Current	Rated Voltage		Normal Wire Gauge
			-10°C~+80°C	-40°C~+105°C		AC	DC	
3pins			M8-CF3-144	M8-CF3-103	3A	60V	60V	24AWG 0.25mm ²
4pins			M8-CF4-148	M8-CF4-107	3A	30V	30V	24AWG 0.25mm ²
5pins			M8-CF5-152	M8-CF5-111	3A	30V	30V	24AWG 0.25mm ²
6pins			M8-CF6-156	M8-CF6-115	1A	30V	30V	26AWG 0.14mm ²
8pins			M8-CF8-160	M8-CF8-119	1A	30V	30V	26AWG 0.14mm ²

Masterlink International Ltd.

Address: 2F., No.90, Sec.2, Xintai 5th Rd., Xizhi Dist., New Taipei City 221, Taiwan (R.O.C.)
 Web Site: www.master-link.com.tw E-mail: info@master-link.com.tw

M8 CONNECTOR / M8 CABLE ASSY'

M8 Male Right Angle Molded Cable, PVC

Illustration

Scale drawing

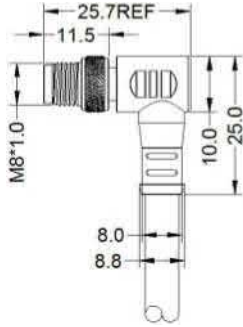

Generally Description:

Connector Series: M8
 Standard: IEC 61076-2-104
 Code: A, B
 Gender: Male
 Connector Design: Moldable Cable Connector
 Connector Locking System: Fix screw
 Waterproof Rating: IP67/IP68
 Normal Temperature: -10°C~+80°C

Material:

Connector Body: TPU
 Contacts: Brass with gold plated
 Screw/Nut: Brass with nickel plated
 Over-mold: TPU
 Cable Jacket: PVC

Electrical data:

Contact Resistance: $\leq 5m\Omega$
 Insulation Resistance: $\geq 100M\Omega$

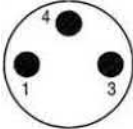
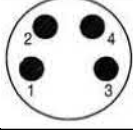
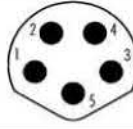
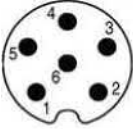
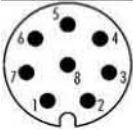
Contacts	A Code	B Code	Part Number		Rated Current	Rated Voltage		Normal Wire Gauge
			-10°C~+80°C	-40°C~+105°C		AC	DC	
3pins			M8-CM3-003	M8-CM3-043	3A	60V	60V	24AWG 0.25mm ²
4pins			M8-CM4-007	M8-CM4-047	3A	30V	30V	24AWG 0.25mm ²
5pins			M8-CM5-011	M8-CM5-051	3A	30V	30V	24AWG 0.25mm ²
6pins			M8-CM6-015	M8-CM6-055	1A	30V	30V	26AWG 0.14mm ²
8pins			M8-CM8-019	M8-CM8-059	1A	30V	30V	26AWG 0.14mm ²

Masterlink International Ltd.

Address: 2F., No.90, Sec.2, Xintai 5th Rd., Xizhi Dist., New Taipei City 221, Taiwan (R.O.C.)
 Web Site: www.master-link.com.tw E-mail: info@master-link.com.tw

M8 CONNECTOR / M8 CABLE ASSY'

M8 Male Right Angle Molded Cable, PUR

Illustration

Scale drawing

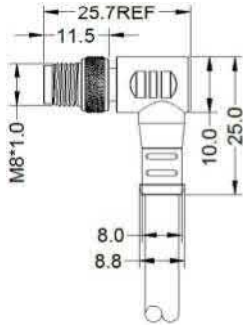

Generally Description:

Connector Series: M8
 Standard: IEC 61076-2-104
 Code: A, B
 Gender: Male
 Connector Design: Moldable Cable Connector
 Connector Locking System: Fix screw
 Waterproof Rating: IP67/IP68
 Normal Temperature: -10°C~+80°C

Material:

Connector Body: TPU
 Contacts: Brass with gold plated
 Screw/Nut: Brass with nickel plated
 Over-mold: TPU
 Cable Jacket: PUR

Electrical data:

Contact Resistance: $\leq 5m\Omega$
 Insulation Resistance: $\geq 100M\Omega$

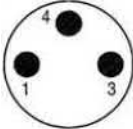
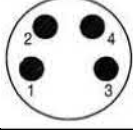
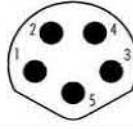
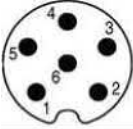
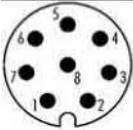
Contacts	A Code	B Code	Part Number		Rated Current	Rated Voltage		Normal Wire Gauge
			-10°C~+80°C	-40°C~+105°C		AC	DC	
3pins			M8-CM3-125	M8-CM3-084	3A	60V	60V	24AWG 0.25mm ²
4pins			M8-CM4-129	M8-CM4-088	3A	30V	30V	24AWG 0.25mm ²
5pins			M8-CM5-133	M8-CM5-092	3A	30V	30V	24AWG 0.25mm ²
6pins			M8-CM6-137	M8-CM6-096	1A	30V	30V	26AWG 0.14mm ²
8pins			M8-CM8-141	M8-CM8-100	1A	30V	30V	26AWG 0.14mm ²

Masterlink International Ltd.

Address: 2F., No.90, Sec.2, Xintai 5th Rd., Xizhi Dist., New Taipei City 221, Taiwan (R.O.C.)
 Web Site: www.master-link.com.tw E-mail: info@master-link.com.tw

M8 CONNECTOR / M8 CABLE ASSY'

M8 Male Right Angle Molded Cable With Shielded, PVC

Illustration

Scale drawing

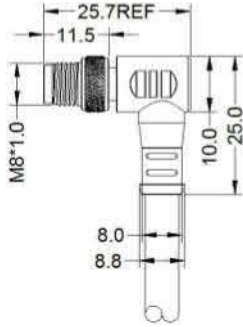

Generally Description:

Connector Series: M8
 Standard: IEC 61076-2-104
 Code: A, B
 Gender: Male
 Connector Design: Moldable Cable Connector
 Connector Locking System: Fix screw
 Waterproof Rating: IP67/IP68
 Normal Temperature: -10°C~+80°C

Material:

Connector Body: TPU
 Contacts: Brass with gold plated
 Screw/Nut: Brass with nickel plated
 Over-mold: TPU
 Cable Jacket: PVC

Electrical data:

Contact Resistance: $\leq 5m\Omega$
 Insulation Resistance: $\geq 100M\Omega$

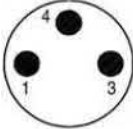
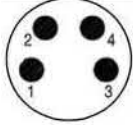
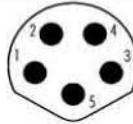
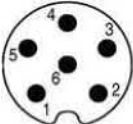
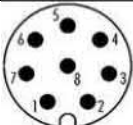
Contacts	A Code	B Code	Part Number		Rated Current	Rated Voltage		Normal Wire Gauge
			-10°C~+80°C	-40°C~+105°C		AC	DC	
3pins			M8-CM3-023	M8-CM3-063	3A	60V	60V	24AWG 0.25mm ²
4pins			M8-CM4-027	M8-CM4-067	3A	30V	30V	24AWG 0.25mm ²
5pins			M8-CM5-031	M8-CM5-071	3A	30V	30V	24AWG 0.25mm ²
6pins			M8-CM6-035	M8-CM6-075	1A	30V	30V	26AWG 0.14mm ²
8pins			M8-CM8-039	M8-CM8-079	1A	30V	30V	26AWG 0.14mm ²

Masterlink International Ltd.

Address: 2F., No.90, Sec.2, Xintai 5th Rd., Xizhi Dist., New Taipei City 221, Taiwan (R.O.C.)
 Web Site: www.master-link.com.tw E-mail: info@master-link.com.tw

M8 CONNECTOR / M8 CABLE ASSY'

M8 Male Right Angle Molded Cable With Shielded, PUR

Illustration

Scale drawing

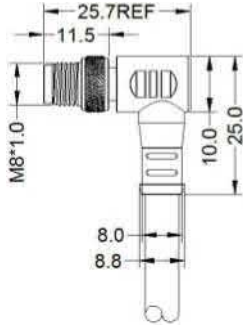

Generally Description:

Connector Series: M8
 Standard: IEC 61076-2-104
 Code: A, B
 Gender: Male
 Connector Design: Moldable Cable Connector
 Connector Locking System: Fix screw
 Waterproof Rating: IP67/IP68
 Normal Temperature: -10°C~+80°C

Material:

Connector Body: TPU
 Contacts: Brass with gold plated
 Screw/Nut: Brass with nickel plated
 Over-mold: TPU
 Cable Jacket: PUR

Electrical data:

Contact Resistance: $\leq 5m\Omega$
 Insulation Resistance: $\geq 100M\Omega$

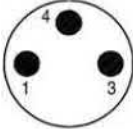
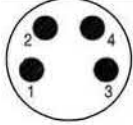
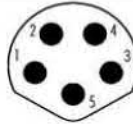
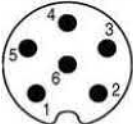
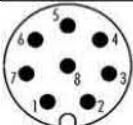
Contacts	A Code	B Code	Part Number		Rated Current	Rated Voltage		Normal Wire Gauge
			-10°C~+80°C	-40°C~+105°C		AC	DC	
3pins			M8-CM3-145	M8-CM4-104	3A	60V	60V	24AWG 0.25mm ²
4pins			M8-CM4-149	M8-CM4-108	3A	30V	30V	24AWG 0.25mm ²
5pins			M8-CM5-153	M8-CM5-112	3A	30V	30V	24AWG 0.25mm ²
6pins			M8-CM6-157	M8-CM6-116	1A	30V	30V	26AWG 0.14mm ²
8pins			M8-CM8-161	M8-CM8-120	1A	30V	30V	26AWG 0.14mm ²

Masterlink International Ltd.

Address: 2F., No.90, Sec.2, Xintai 5th Rd., Xizhi Dist., New Taipei City 221, Taiwan (R.O.C.)
 Web Site: www.master-link.com.tw E-mail: info@master-link.com.tw

M8 CONNECTOR / M8 CABLE ASSY'

M8 Female Right Angle Molded Cable, PVC

Illustration

Scale drawing

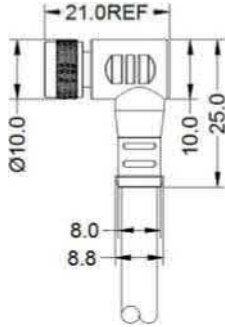

Generally Description:

Connector Series: M8
 Standard: IEC 61076-2-104
 Code: A, B
 Gender: Female
 Connector Design: Moldable Cable Connector
 Connector Locking System: Fix screw
 Waterproof Rating: IP67/IP68
 Normal Temperature: -10°C~+80°C

Material:

Connector Body: TPU
 Contacts: Phosphorus copper with gold plated
 Screw/Nut: Brass with nickel plated
 Over-mold: TPU
 Cable Jacket: PVC

Electrical data:

Contact Resistance: $\leq 5m\Omega$
 Insulation Resistance: $\geq 100M\Omega$

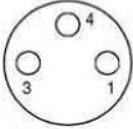
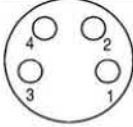
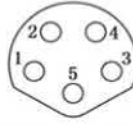
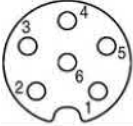
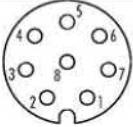
Contacts	A Code	B Code	Part Number		Rated Current	Rated Voltage		Normal Wire Gauge
			-10°C~+80°C	-40°C~+105°C		AC	DC	
3pins			M8-CF3-004	M8-CF3-044	3A	60V	60V	24AWG 0.25mm ²
4pins			M8-CF4-008	M8-CF4-048	3A	30V	30V	24AWG 0.25mm ²
5pins			M8-CF5-012	M8-CF5-052	3A	30V	30V	24AWG 0.25mm ²
6pins			M8-CF6-016	M8-CF6-056	1A	30V	30V	26AWG 0.14mm ²
8pins			M8-CF8-020	M8-CF8-060	1A	30V	30V	26AWG 0.14mm ²

Masterlink International Ltd.

Address: 2F., No.90, Sec.2, Xintai 5th Rd., Xizhi Dist., New Taipei City 221, Taiwan (R.O.C.)
 Web Site: www.master-link.com.tw E-mail: info@master-link.com.tw

M8 CONNECTOR / M8 CABLE ASSY'

M8 Female Right Angle Molded Cable, PUR

Illustration

Scale drawing

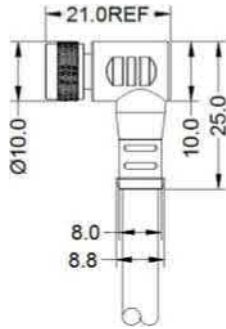

Generally Description:



Connector Series: M8
 Standard: IEC 61076-2-104
 Code: A, B
 Gender: Female
 Connector Design: Moldable Cable Connector
 Connector Locking System: Fix screw
 Waterproof Rating: IP67/IP68
 Normal Temperature: -10°C~+80°C

Material:

Connector Body: TPU
 Contacts: Phosphorus copper with gold plated
 Screw/Nut: Brass with nickel plated
 Over-mold: TPU
 Cable Jacket: PUR

Electrical data:

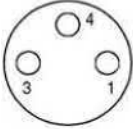
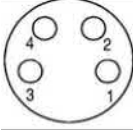
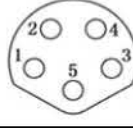
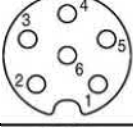
Contact Resistance: $\leq 5m\Omega$
 Insulation Resistance: $\geq 100M\Omega$

Contacts	A Code	B Code	Part Number		Rated Current	Rated Voltage		Normal Wire Gauge
			-10°C~+80°C	-40°C~+105°C		AC	DC	
3pins			M8-CF3-126	M8-CF3-085	3A	60V	60V	24AWG 0.25mm ²
4pins			M8-CF4-130	M8-CF4-089	3A	30V	30V	24AWG 0.25mm ²
5pins			M8-CF5-134	M8-CF5-093	3A	30V	30V	24AWG 0.25mm ²
6pins			M8-CF6-138	M8-CF6-097	1A	30V	30V	26AWG 0.14mm ²
8pins			M8-CF8-142	M8-CF8-101	1A	30V	30V	26AWG 0.14mm ²

Masterlink International Ltd.

Address: 2F., No.90, Sec.2, Xintai 5th Rd., Xizhi Dist., New Taipei City 221, Taiwan (R.O.C.)
 Web Site: www.master-link.com.tw E-mail: info@master-link.com.tw

M8 CONNECTOR / M8 CABLE ASSY'

M8 Female Right Angle Molded Cable With Shielded, PVC

Illustration

Scale drawing

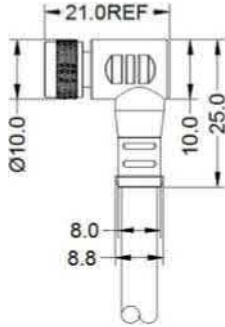

Generally Description:



Connector Series: M8
 Standard: IEC 61076-2-104
 Code: A, B
 Gender: Female
 Connector Design: Moldable Cable Connector
 Connector Locking System: Fix screw
 Waterproof Rating: IP67/IP68
 Normal Temperature: -10°C~+80°C

Material:

Connector Body: TPU
 Contacts: Phosphorus copper with gold plated
 Screw/Nut: Brass with nickel plated
 Over-mold: TPU
 Cable Jacket: PVC

Electrical data:

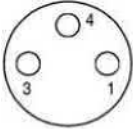
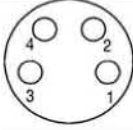
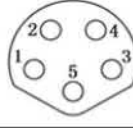
Contact Resistance: $\leq 5m\Omega$
 Insulation Resistance: $\geq 100M\Omega$

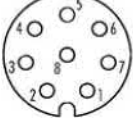
Contacts	A Code	B Code	Part Number		Rated Current	Rated Voltage		Normal Wire Gauge
			-10°C~+80°C	-40°C~+105°C		AC	DC	
3pins			M8-CF3-024	M8-CF3-064	3A	60V	60V	24AWG 0.25mm ²
4pins			M8-CF4-028	M8-CF4-068	3A	30V	30V	24AWG 0.25mm ²
5pins			M8-CF5-032	M8-CF5-072	3A	30V	30V	24AWG 0.25mm ²
6pins			M8-CF6-036	M8-CF6-076	1A	30V	30V	26AWG 0.14mm ²
8pins			M8-CF8-040	M8-CF8-080	1A	30V	30V	26AWG 0.14mm ²

Masterlink International Ltd.

Address: 2F., No.90, Sec.2, Xintai 5th Rd., Xizhi Dist., New Taipei City 221, Taiwan (R.O.C.)
 Web Site: www.master-link.com.tw E-mail: info@master-link.com.tw

M8 CONNECTOR / M8 CABLE ASSY'

M8 Female Right Angle Molded Cable With Shielded, PUR

Illustration

Scale drawing

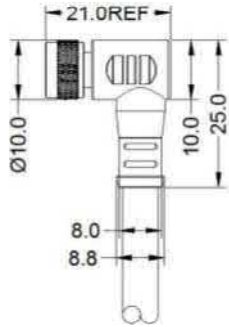

Generally Description:



Connector Series: M8
 Standard: IEC 61076-2-104
 Code: A, B
 Gender: Female
 Connector Design: Moldable Cable Connector
 Connector Locking System: Fix screw
 Waterproof Rating: IP67/IP68
 Normal Temperature: -10°C~+80°C

Material:

Connector Body: TPU
 Contacts: Phosphorus copper with gold plated
 Screw/Nut: Brass with nickel plated
 Over-mold: TPU
 Cable Jacket: PUR

Electrical data:

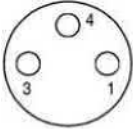
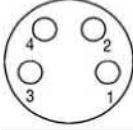
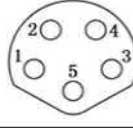
Contact Resistance: $\leq 5m\Omega$
 Insulation Resistance: $\geq 100M\Omega$

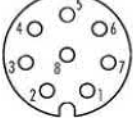
Contacts	A Code	B Code	Part Number		Rated Current	Rated Voltage		Normal Wire Gauge
			-10°C~+80°C	-40°C~+105°C		AC	DC	
3pins			M8-CF3-146	M8-CF3-105	3A	60V	60V	24AWG 0.25mm ²
4pins			M8-CF4-150	M8-CF4-109	3A	30V	30V	24AWG 0.25mm ²
5pins			M8-CF5-154	M8-CF5-113	3A	30V	30V	24AWG 0.25mm ²
6pins			M8-CF6-158	M8-CF6-117	1A	30V	30V	26AWG 0.14mm ²
8pins			M8-CF8-162	M8-CF8-121	1A	30V	30V	26AWG 0.14mm ²

Masterlink International Ltd.

Address: 2F., No.90, Sec.2, Xintai 5th Rd., Xizhi Dist., New Taipei City 221, Taiwan (R.O.C.)
 Web Site: www.master-link.com.tw E-mail: info@master-link.com.tw

M8 CONNECTOR / M8 CABLE ASSY'

M8 One Male To Two Female Y Splitter Connector

Illustration

Scale drawing

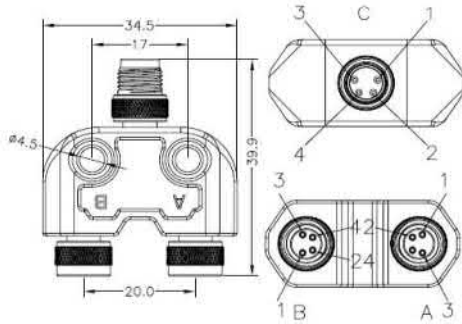

Generally Description:

Connector Series: M8
 Standard: IEC 61076-2-104
 Code: A, B
 Gender: Male, Female
 Connector Design: Moldable Cable Connector
 Connector Locking System: Fix screw
 Waterproof Rating: IP67/IP68
 Normal Temperature: -10°C~+80°C

Material:

Connector Body: TPU
 Contacts: Brass/Phosphorus copper with gold plated
 Screw/Nut: Brass with nickel plated
 Over-mold: PVC

Electrical data:

Contact Resistance: $\leq 5m\Omega$
 Insulation Resistance: $\geq 100M\Omega$

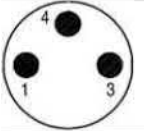
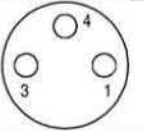
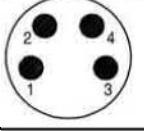
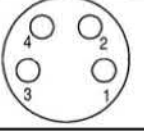
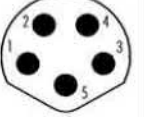
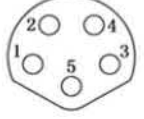
Contacts	A Code Male	A Code Female	B Code Male	B Code Female	Part Number	Rated Current	Rated Voltage	Normal Wire Gauge
							AC/DC	
3pins					M8-YC3-001	3A	60V	24AWG 0.25mm ²
4pins					M8-YC4-002	3A	30V	24AWG 0.25mm ²
5pins					M8-YC5-003	3A	30V	24AWG 0.25mm ²